

Prot. 68125 del 28/10/20



PREVENTIVO N. 240MC20/NB/DP/eg

Spettabile
ASL RIETI
Via del Terminillo, n. 42
RIETI

Arre, 13 ottobre 2020

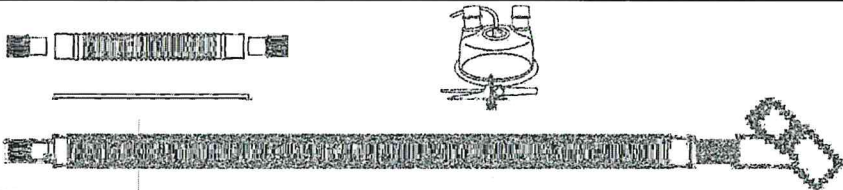

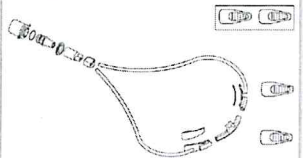
PREVENTIVO:

Codice	Descrizione	Q.tà	Importo €uro
			
GGM-VA4213-31 CND: R0680 Repertorio n.: 1250553/R	Circuito monouso singolo riscaldato 150cm HF Completo di camera di umidificazione ad auto riempimento Prezzo.....€	1 Cf. da 10 pz.	<u>600,00</u>

Codice	Descrizione	Pz/Cf	Importo €uro
	 		
GGM-HFN-1000 CND: R0680 Repertorio n.: 1806465/R	Nasocannula alti flussi mis. neonatale OD 2.5 mm - Distanza setto 3 mm Flusso massimo 6 LPM – colore giallo Prezzo.....€	1 Cf. da 10 pz.	<u>350,00</u>
GGM-HFN-1001 CND: R0680 Repertorio n.: 1364519/R	Nasocannula alti flussi mis. neonatale OD 2.5 mm - Distanza setto 5 mm Flusso massimo 6 LPM – colore arancione Prezzo.....€	1 Cf. da 10 pz.	<u>350,00</u>
GGM-HFN-1002 CND: R0680 Repertorio n.: 1365764/R	Nasocannula alti flussi mis. neonatale OD 3.5 mm - Distanza setto 7 mm Flusso massimo 18 LPM – colore azzurro Prezzo.....€	1 Cf. da 10 pz.	<u>350,00</u>
GGM-HFN-1003 CND: R0680 Repertorio n.: 1806491/R	Nasocannula alti flussi mis. neonatale OD 3 mm - Distanza setto 6 mm Flusso massimo 15 LPM – colore blu Prezzo.....€	1 Cf. da 10 pz.	<u>350,00</u>

I prezzi si intendono al netto di IVA 22%

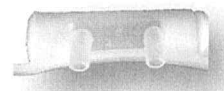
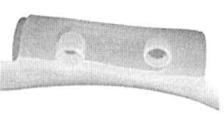
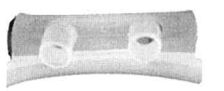
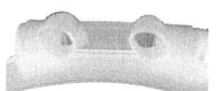
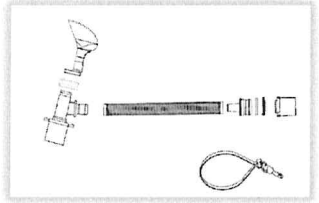
PREVENTIVO N. 240MC20/NB/DP/eq

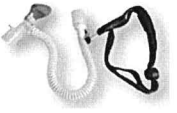
Codice	Descrizione	Pz/Cf	Importo €uro
 <p>CND: R0680 Repertorio n.: 1250453/R</p>			
GGM-HFN-0001 	Cannula nasale pediatrica – mis. S 4 mm., 35 lpm – conf. da 10 pezzi – colore bianco Prezzo.....€	1 Cf. da 10 pz.	<u>350,00</u>
GGM-HFN-0002 	Cannula nasale adulto/infante – mis. M 5 mm., 45 lpm – conf. da 10 pezzi – colore viola Prezzo.....€	1 Cf. da 10 pz.	<u>350,00</u>
GGM-HFN-0003 	Cannula nasale adulto – mis. L 6 mm., 60 lpm – conf. da 10 pezzi colore blu scuro Prezzo.....€	1 Cf. da 10 pz.	<u>350,00</u>
GGM-HFN-0004 	Cannula nasale adulto – mis. XL 7 mm., 70 lpm – conf. da 10 pezzi – colore rosa Prezzo.....€	1 Cf. da 10 pz.	<u>350,00</u>
Codice	Descrizione	Pz/Cf	Importo €uro
			
GGM-HFN-0006 CND: R0680 Repertorio n.: 1364490/R	Interfaccia tracheostomica mis. pediatrica OD 3.5 mm Flusso massimo 5-15 LPM colore rosa Prezzo.....€	1 Cf. da 10 pz.	 <u>350,00</u>
GGM-HFN-0007 CND: R0680 Repertorio n.: 1366161/R	Interfaccia tracheostomica mis. adulto OD 5 mm Flusso massimo 15-50 LPM Colore blu Prezzo.....€	1 Cf. da 10 pz.	 <u>350,00</u>



I prezzi si intendono al netto di IVA 22%

PREVENTIVO N. 240MC20/NB/DP/eq

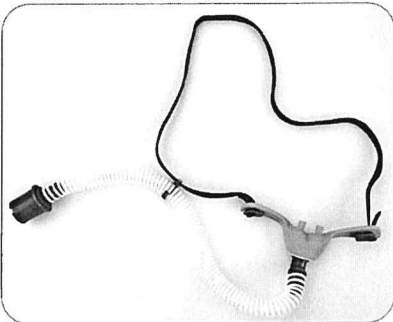
ALTRE INTERFACCE DISPONIBILI



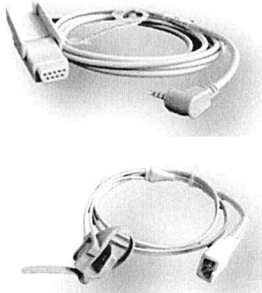

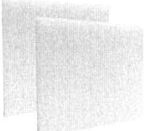
Codice	Descrizione	Pz/Cf	Importo €uro
			
RVH001M CND: R0680 Repertorio n.: 1929975/R	Nasocannula alti flussi universale Flusso da 4 a 60 LPM Prezzo.....€	1 Cf. da 10 pz.	<u>240,00</u>

OPZIONI E RICAMBI

Codice	Descrizione	Pz/cf	Importo €uro
GGM-HF-PS-2900203 	Sensore SpO2 a dito Adulto	1 pz.	<u>340,00</u>
GGM-HF-PS-2900208 	Cavo prolunga (cod. C0007H) sensore pluriuso neonatale (SF1002P)	1 pz.	<u>420,00</u>
GGM-HF-PS-2900008 	Filtro Aria – conf. da 5 pz.	5 pz.	<u>240,00</u>
GGM-VF-2206 	Filtro Antibatterico – conf. da 5 pz.	5 pz.	<u>290,00</u>

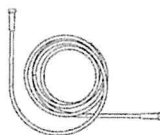
I prezzi si intendono al netto di IVA 22%

PREVENTIVO N. 240MC20/NB/DP/eq

Codice	Descrizione	Pz/cf	Importo Euro
 GGM-VH-P-VH-1161-003	Tubo ingresso O2 – conf. da 5 pz.	5 pz.	<u>180,00</u>
 GGM-HN-70059	Adattatore O2 – conf. da 5 pz.	5 pz.	<u>240,00</u>
 GGM-HWA-2900G01	Adattatore del filo riscaldante	1 pz.	<u>235,00</u>
 GGM-HU-2555	Connettore O2 – conf. da 5 pz.	5 pz.	<u>225,00</u>

I prezzi si intendono al netto di IVA 22%

IMPORTO MINIMO FATTURABILE: €uro 300,00 + IVA

Per ordini di importo inferiore: € 50,00 contributo spese

CONDIZIONI DI FORNITURA

Resa:	Franco DESTINO	Imballo:	Compreso
Consegna:	entro 60 gg. data ordine	Pagamento:	60 GG DF
Validità Preventivo:	90 GG.	IVA 22%:	a Vs. carico

In linea con la politica di continua evoluzione dei prodotti, la Società si riserva di apportare modifiche tecnico-scientifiche senza preavviso.

Restiamo a Vs. disposizione per eventuali chiarimenti in merito e con l'occasione porgiamo distinti saluti.

EUROMED srl
Nicola Bortoletto
AMMINISTRATORE UNICO

